

BOSSTOW® bars



Code

EUROPE
tested
94/20/EC

Type Nr.

max.

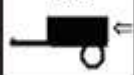

max.
vertikal
load

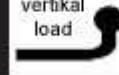

max.
D-Wert

Produced: GALIA SLOVAKIA s.r.o., Vlachy1 42,
SK- 032 13 Vlachy Europe

**Audi A6, Lim., Kombi,
Allroad Quattro 2011-**

A0495

e27*55R*0057*00







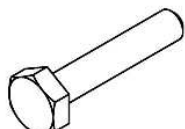
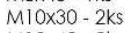
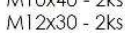
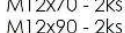

A049

2500

100

12,4

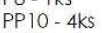
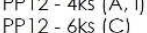
Seite/ Page 1 / 2

-  M8x40 - 1ks
-  M10x30 - 2ks
-  M10x40 - 2ks
-  M12x30 - 2ks
-  M12x70 - 2ks (A,I)
-  M12x90 - 2ks (I)
-  M12x19 - 4ks (C)
-  SM8 - 1ks
-  M12 - 4ks (A, I)
M12 - 2ks (C)
-  P8 - 1ks
-  PP10 - 4ks
-  PP12 - 4ks (A, I)
PP12 - 6ks (C)
-  P11 - 4ks
-  PR14 - 1ks

C

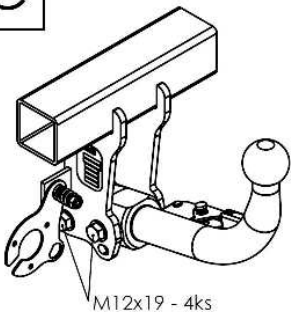

**DETAIL
AUDI A6**

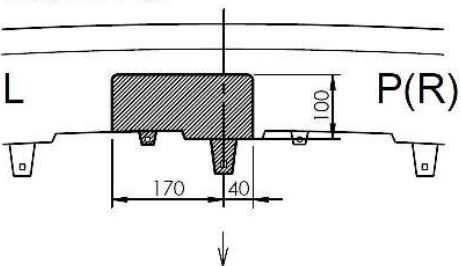

DETAIL 1

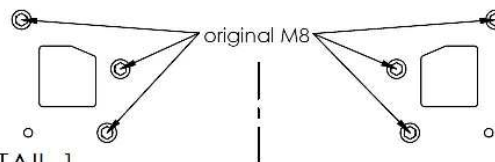

I

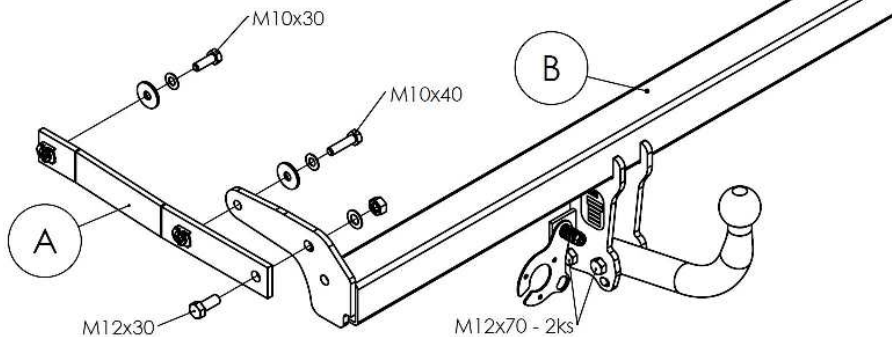
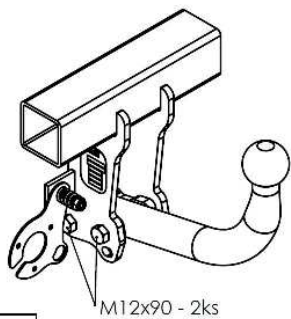









AIC 400 12.3

AUDI A6, AUDI A6 KOMBI, AUDI A6 ALLROAD, AUDI A7
Kód: A0495(A,I,C) 25. 3. 2013

A

Drehmomentangaben Torgue settings
(8.8)

Nuts/ Bolts Schrauben/Muttern	Spanner Drehmoment
M8	23 Nm
M10	46Nm
M12	79 Nm
M14	125 Nm
M16	195 Nm

							
<p>Produced: GALIA SLOVAKIA s.r.o., Vlachy1 42, SK- 032 13 Vlachy Europe</p>	<p>Audi A6, Lim., Kombi, Allroad Quattro 2011-</p>	<p>A0495</p>	<p>e27*55R*0057*00</p>	<p>A049</p>	<p>2500</p>	<p>100</p>	<p>12,4</p>
<p>Seite/ Page 2 / 2</p>							

ERROR: undefined
OFFENDING COMMAND: mF\$F3S43YFFFFFB5

STACK:

[67.211 0 0 -75 0 0]
-dictionary-
/F3S43YFFFFFB5